



























































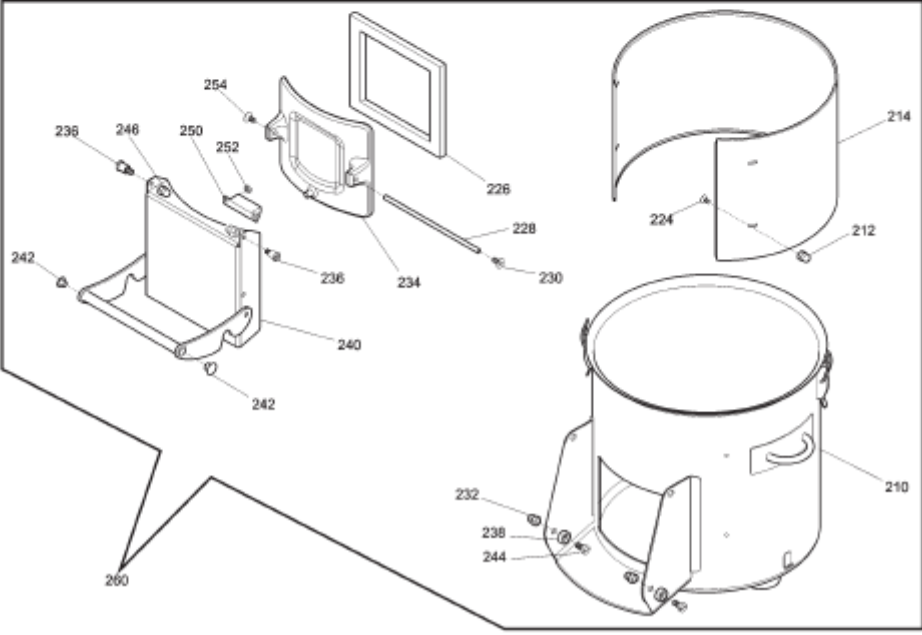
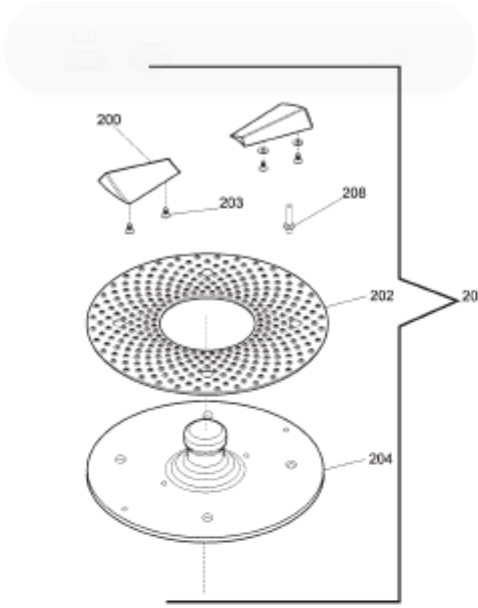















PPJ 20 SC CE

	REF	ART	COD
	02	COPERCHIO ACCIAIO SALDATO PPJ20SC	IV2090620E
	03	MAGNETE IP67	IV5820520IP
	04	SCREW-TYPE MAGNET M10 FOR TC MAGNUM	IV5820510
	06	ASTA SUPP. MICRO PPJ SC 20	IV75ASM18
	08	DADO ALTO M16 X ASTA MICRO PPJ	IV75DM16A
	10	CARCASSA ACCIAIO PPJ20SC	IV2486608
	12	ANTI-VIBRANT FEET, POTATO PEELER	IV4600600
	16	WASHER 08 x 24 INOX	IV77R08X24
	18	NUT M 08	IV77D08
	20	CONTAINER LOCKING _ PPJ	IV7700020
	22	NUT M 05	IV77D05
	26	SCREW M5 PPJ	IV77VE05X10
	30	TIMER 1-PHASE _ PPJ 10/20 CE/NON CE	★ IV5966010
	36	KNOB FOR TIMER PPJ	IV5966011
	40	START-OUT BUTTON _ PPJ	IV5940601
	44B	CIRCUIT BOARD 220-380 3-PHASE	★ 19411008
	44A	ELEKTRONISCHE PLATINE 220Volts	★ 19411007
	46	ELEKTRON. SCHALTER FUER AUFSCH.	★ 19702004
	47	GUMMI FUER EIN/AUS SCHALTER	19563034
	48	COPERTURA INF. PPJ20SC	IV2486620
	50	FLANGED FOOT for potatopeeler	IV4630600
	52	PIEDINI NON FLANGIATI PLP	IV4630605
	54	PRESSACAVO PG 11	IV5890302
	56	CAVO ALIMENTAZIONE MN PG	IV5503006

	60B	MOTOR FUER KARTOFFELSCHALER PPJ20	IV5056603
	60A	MOTORE MEC90L 230V/50MN PPJ 20	IV5056602
	61	GRANO M6X08	IV75G06X08
	70	PULLEY MEC 90/100 D.33	IV1320620
	78	MOTOR SUPPORT FLANGE _ PPJ 10 SC	IV2400659
	80	CONDENSATORE 35 MF PER PPJ MONOFASE	IV5820035P
	88	BELT 508 - PPJ 20 SC	IV7000605
	92	SCREW M6 X 18	IV77VEI06X18
	94	WASHER M6 X 20	IV77R06X20
	98	PULLEY FOR POTATO PEELER	IV1020615
	100	BEARING HOLDER FOR PP	IV1080605
	102	SCREW M6 X 12 PLP	IV77VEI06X12
	104	WASHER M6	IV77R06
	106	BALL BEARING 6303 2RS _ PPJ	IV7300600
	108	BEARING SPACER _ PPJ	IV2080610
	110	SPACER, BALL BEARINGS	IV2080615
	112	CONTAINER SHAFT GASKET FOR PP	IV4100610
	116	BALL BEARING 62303 2RS _ PPJ	IV7300605
	118	FIXING KEY _ PPJ	IV76C5X5X20
	120	SHAFT - POTATO PEELER	IV2080600
	122	KEY 7 X 8 X 15 FOR PPJ	IV77C7X8X15
	128	SHAFT GASKET FOR PP	IV7200600
	130	MOTOR FLANGE PPJ SC	IV1020610
	134	WATER INLET PPJ	IV7800600
	140	SCREW-TYPE MAGNET M10 FOR TC MAGNUM	IV5820510
	150	MANIGLIA VASCHETTA GRATT.TCG DKT	29561652



PPJ 20 SC CE

	REF	ART	COD	€
	200	RIALZO PIATTELLO BRILLANT. PPJ 20 	IV1086625	
	201	PEELING DISC POTATO PEELER PPJ20	IV98406220	
	202	PEELING DISC FOR PPJ 20 	IV2426600	
	203	VITE SVASATA 6 X 16 PLP	IV77TSEI6X16	
	204	PIATTELLO BRILLANTATO PPJ 20	IV1086100	
	205	VITE SVASATA 6 X 12 PLP	IV77TSEI6X12	
	210	CONTAINER _ PPJ 20	IV2226610	
	214	SIDE ABRASIVE SURFACE _ PPJ20	IV2426695	
	216	S/Steel LID PPJ 20	IV2096600	
	226	DOOR GASKET PPJ20 	IV4130610	
	228	PIN - LOCK DOOR PPJ	IV2080635	
	234	INSIDE DOOR FRAME FOR PPJ	IV1020640	
	236	DOOR SCREW FOR PPJ	IV2080645	
	238	NEEDLE-ROLLER - DOOR PPJ	IV2080655	
	240	DOOR ASSEMBLY FOR POTATO PEELER	IV9800680	
	242	HANDLE CAP FOR PPJ	IV4210600	
	244	SCREW - DOOR PPJ	IV2080650	
	246	BLIND NUT M 6	IV77DC06	
	250	MAGNETIC SWITCH	LF1050103	
	260	CONTAINER ASSEMBLY PPJ20	IV9800676	